



## VARIABLE SPEED FREQUENCY INVERTER with Digital Timers



### eSavr Models 1100 & 2200

Thank you for purchasing the eSavr Variable Speed Pump Controller. Please read the carefully before installation & operation and keep for future reference after installation









## CONTENTS

1.	IMPORTANT SAFETY INSTRUCTIONS .....	1
2.	TECHNICAL DATA .....	1
3.	BEFORE INSTALLATION .....	2
4.	CONNECTING TO POOL PUMP .....	2
5.	SETTINGS & OPERATION.....	4
6.	PROTECTON & ERROR CODES.....	6
7.	EXEMPTIONS .....	7
8.	E-WASTE DISPOSAL (WEEE- Waste Electrical Equipment) .....	7

## SAFETY SYMBOLS

	Read and keep the manual in a safe place
	Warning
	Caution: Risk of electrical shock
	Do not touch the heat sink
	e-Waste: Dispose at recycling centre

## 1. IMPORTANT SAFETY INSTRUCTIONS



To make the best use of this energy saving device and to avoid potential risk of fire, electrical shock, **SERIOUS** injury to people or damage to property, please read this user guide carefully before installation and keep it for future reference.

**PSC:** This device can ONLY be used with pool pumps with permanent split capacitor motor. The schematic diagram below shows a typical single speed swimming pool pump motor.

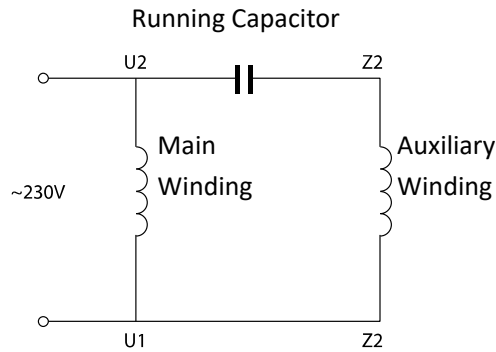

Fig 1

1.1 This device is NOT compatible with:

- a. Single phase motors with centrifugal switch
- b. Pool pump motors with start relays or switch
- c. Series or DC motors
- d. Pool pump motors with faults in their rotors or capacitors
- e. Shaded-pole asynchronous motors

1.2 An RCD with a rated residual current not exceeding 30mA must be used with this product.



If you are not sure of the compatibility of your pool pump with this device, please contact your supplier or manufacturer before proceeding with installation.

## 2. TECHNICAL DATA

Model	eSavr 1100	eSavr 2200	Dimensions
Input power	Single phase AC	single phase AC	
Input voltage	220~240V	220~240V	
Input frequency	50Hz	50Hz	
Max. Input power	1.1kW	2.2 kW	
Output Voltage	1ph, 0~240V	1ph, 0~240V	
Pump type	Single phase	Single phase	
Max. current	Max 6A	Max 12A	
Speed range	1200~2900 rpm	1200~2900 rpm	
Cooling	Heat Sink	Heat Sink/Fan	
Net Dimension (L*H*W)	187*110*155mm	187*110*155mm	
Gross/Net Weight	3.0 / 2.7kg	3.0 / 2.7kg	

### 3. BEFORE INSTALLATION



Upon receipt of this device, check for any damages to the packaging or product. **DO NOT PROCEED** with installation if any damage is found, contact your supplier.

Do not use extension leads with the device. This can pose a danger particularly in the vicinity of a swimming pool.

Make sure the place you choose for installation meets the following conditions:

- Ambient temperature from -10~40°C
- 45 to 90 percent relative humidity, non-condensing
- Less than 1000m above sea level
- Must be kept out of direct sunlight
- Good ventilation

For efficient cooling, please make sure it is installed with a minimum clearance surrounding it(Fig2), blocked ventilation or an enclosed space with limited air flow may cause overheating or potential failure of the inverter.

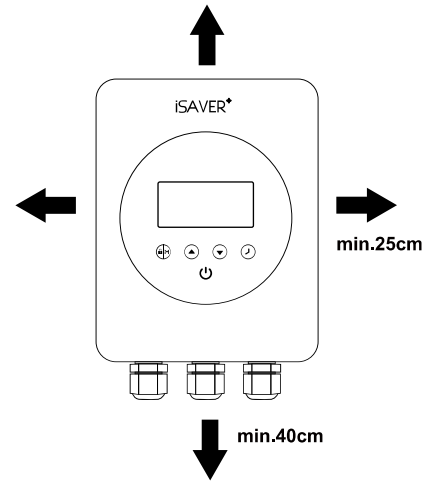

Fig. 2

### 4. CONNECTING TO POOL PUMP

Please follow these steps and the wiring diagram for correct connection. Warranty may be voided if the device is not installed in accordance with the instructions described in this manual

Only ONE pump can be connected to the inverter. Please do not connect any other appliance to the output.

Mark the hole locations on the wall, Drill and insert the expansion plugs supplied, fit the screws and hang the device on screws.

- 4.1 Turn off all electrical supply to the pool pump, unplug it from the main switch or at the chlorinator which provides electrical power to the pump.
- 4.2 Plug the pool pump into the device's power outlet (marked PUMP CONNECTION ONLY).
- 4.3 Plug the device into the main switch/chlorinator/timer connection where the pump was originally plugged into.
- 4.4 Switch all power back on.
- 4.5 Ensure chlorinator/timer is active.
- 4.6 Now the device is ready to operate.

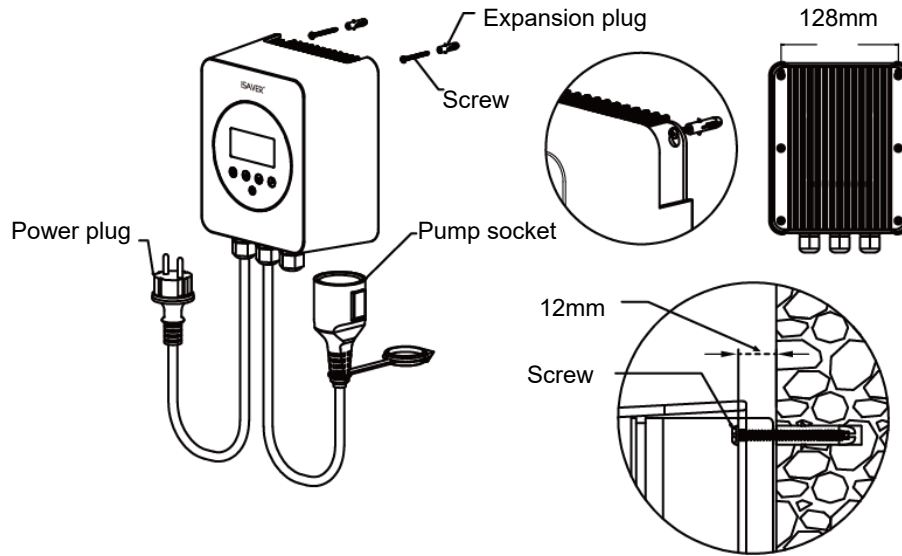

**Fig. 3**

Above figure is for reference only, plug & socket may vary for different countries/regions.

If you do not require a power plug for installation, wire the device as shown in Fig.4, please.

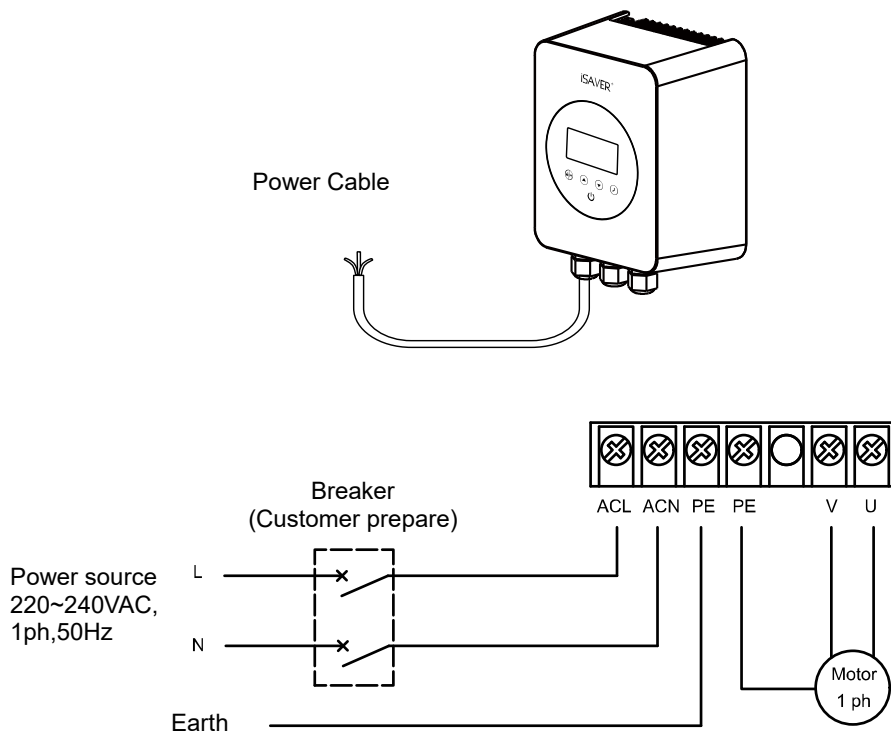

**Fig. 4**



**Do not touch the heat sink while the device is in operation or until at least 30 mins after it has been switched off. Keep it out of reach of children.**



**Because of high voltage conversion components contained in the device, do not try to disassemble or replace any components in case of malfunction or breakdown. Before serving on the unit, wait till the power light turned off or at least 3 minutes after power plug has been plugged off from input supply.**

## 5. SETTINGS & OPERATION

### 5.1 Control panel

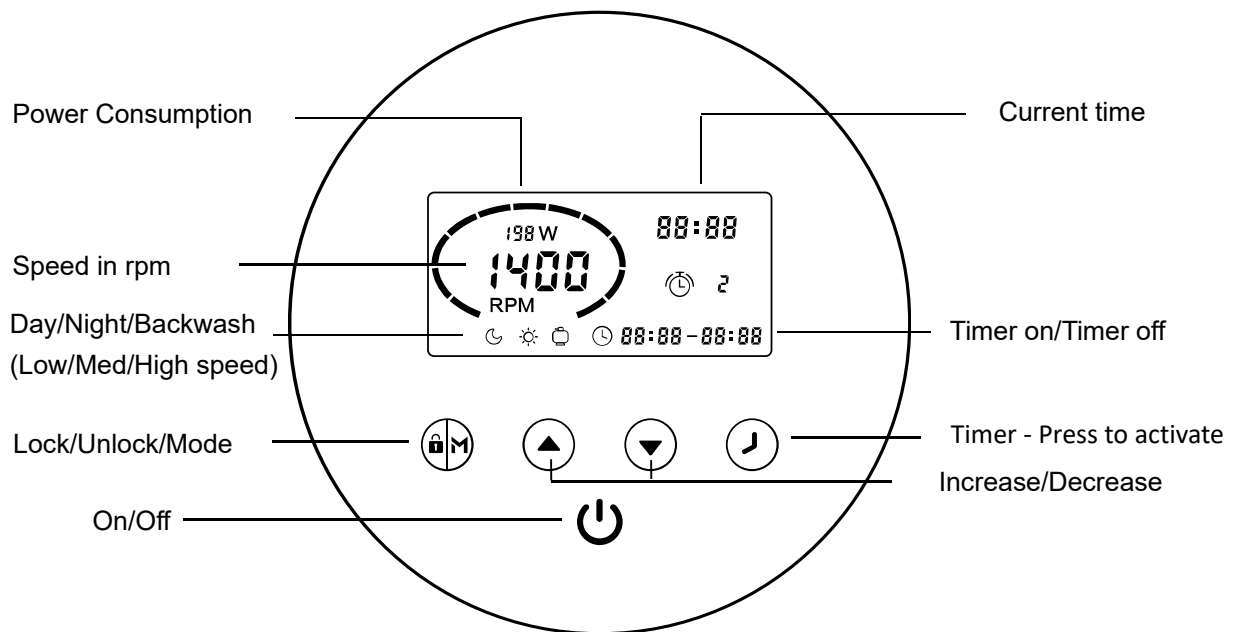

### 5.2 Mode selection

The frequency inverter has 3 modes(speed ranges).You can either run your pump at a constant speed choosing from “M” (Mode) at Low Medium High

Or set up to 4 timers for daily operation, each with an individual speed.

Mode	Speed range	Default speed
Night (Low)	1200~1650 rpm	1400 rpm
Day (Medium)	1700~2400 rpm	2000 rpm
Backwash(High)	2450~2900 rpm	2900 rpm





- ① When plugged in, lights up, hold for 3 seconds to unlock the screen. Press to start.
- ② Upon starting, pump will run at maximum speed of 2900 rpm for one-minute self-priming. (This can be increased to 10 minutes – see Parameter settings Section 5.5)
- ③ Press to choose a running speed, use or arrows to adjust by 50 rpm to a specific running speed if required.



Once the pump has finished priming, the inverter will automatically switch the pump to the pre-set speed, indicates the pump is running and showing current rpm and power consumption.



### 5.3 Timer setting

To run the pump at a different times or speeds to take advantage of lower electricity tariffs during the night, you can set up to 4 timers.

**Step1:** Press to  enter timer setting.

**Step2:** Use  or  to set current time. Press  to move cursor to the next setting. Press  to

Choose a speed range for timer 1, use  or  to decide on a specific speed if needed.

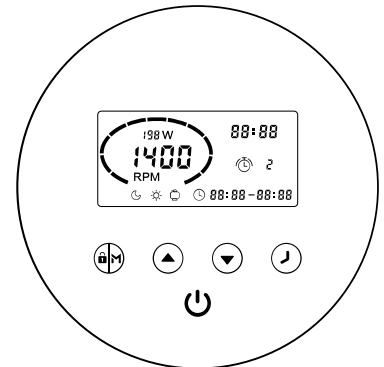

Press   to move cursor to previous setting.



**Step3:** Repeat the above steps to set the other 3 timers (if required)

**Step4:** Hold  for 3 seconds or wait 10 seconds to save settings automatically.

A flashing  **00:00-00:00** indicates the device is waiting for start time.

**Step5:** press  or  to check all 4 timers to ensure there are no invalid settings. (e.g. time overlap)



Any overlapping of timer periods will be considered as invalid and the device will only run based on the previous valid timer setting.

\* During timer setting, if you want to abandon it, hold  for 3 second.

#### Note:

\* If inactivate for 1 minute, the screen will lock automatically. Hold  for 3 seconds to unlock the device.

\* The device has power-off memory, operation will resume upon power restoration.

\* Under OFF mode, hold   for 3 seconds to retrieve factory setting.

### 5.4 External control

External control can be enabled via the following contacts. However, even if it's working via an external control, Pressing  can stop the device.

Please do not apply voltage to these inputs.



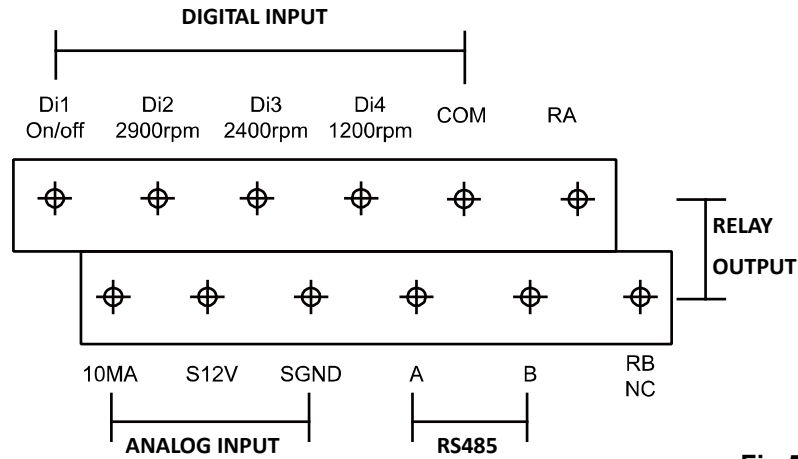

Fig 5

E.g.: To enable external speed control via digital input, connect one of the terminals from Di2/3/4 to COM.

### 5.5 Parameter setting

While in OFF mode, hold for 3 seconds to enter parameter settings.

Parameter	Description	Default setting	Setting range
1	Priming time	1 minutes	1~10min, by 1 minute increments
2	Minimum RPM	1200rpm	1200~2000rpm, by 100rpm increments

## 6. PROTECTON & ERROR CODES

Item	Code	Description	Analysis
1	E001	Abnormal input voltage	Not faulty
2	E002	Output over current – unplug for 3 minutes; restart	Not faulty
3	E101	Heat sink over heat	Contact your supplier
4	E102	Heat sink sensor error	Contact your supplier
5	E103	Master driver board error	Contact your supplier
6	E201	Circuit board error	Contact your supplier
7	E202	Master board EEPROM reading failure	Contact your supplier
8	E203	RTC time reading error	Contact your supplier
9	E204	Keyboard EEPROM reading failure	Contact your supplier
10	E205	Communication error	Contact your supplier
11	AL01	Auto speed reduction against high temperature	Not faulty

Note:

1. AL01 is not an error indication: when it appears the inverter will automatically switch to a lower speed to self protect against high internal temperature. When the temperature drops back to 65°C the inverter will resume at the preset speed.
2. When the reason for E002/E101/E103 is removed, the device will resume working automatically. However when it appears a fourth time, the device will stop working, to resume operation, simply unplug the device for a few minutes and then plug in & restart again.

## **WARRANTY**

The inverter comes with guarantees that cannot be excluded under consumer law of the country of purchase. The manufacturer warrants that the inverter product will be free from defective materials and construction for TWO years since the date of purchase but are subject to the exclusions below.

Warranty does not extend to normal wear and tear; adverse environmental or weather conditions such as storms, flooding, or excessive heat wave damage.

If a defect appears in the inverter product before the end of the warranty period, and the manufacturer finds the product to be defective in materials or parts, the manufacturer will at its sole discretion choose to repair or replace the product free of charge.

## **7. EXEMPTIONS**

Under no circumstances should the manufacturer be held liable for any consequences resulting from inappropriate, incorrect installation, or mismatching of the product to pool pumps that are not compatible.

The manufacturer reserves the right to change the specification of the product or its performance or the contents of the User Guide without notice in case of technical upgrade.

## **8. E-WASTE DISPOSAL (WEEE- Waste Electrical Equipment)**



When disposing the product, please hand it over to a designated collection point for the recycling of waste electrical and electronic equipment.

If improperly disposed, electronic waste like old computers, mobile phones and kitchen appliances, can pose environmental and health risks from exposure to lead, mercury and other heavy metals.

The separate collection and recycling of waste equipment at the time of disposal will help ensure that it is recycled in a proper manner. Contact your local authority for information on where you can drop off your electrical item for recycling.



